

The Exploitation of Using Sliding Table Controller in Blood Glucose-Insulin System for Diabetes

Ahmed Y. Ben Sasi
College of Industrial Technology
Misurata, Libya
ahmed_bensasi@yahoo.co.uk

Mahmud A. Elmalki
Misurata University
Misurata, Libya
elmalki_m@yahoo.com

Abstract— A discrete insulin infusion based on long-time interval measurement is the classic technique for diabetes treatment. Nevertheless, in this research, a closed-loop control system was proposed for continuous drug infusion to overcome the drawbacks of these typical discrete methods and develop more practical diabetes therapy systems. A blood glucose-insulin system was implemented relying on continuous insulin injection model. Based on this model, two controllers were designed to deal with the control dilemma of the resulting highly nonlinear plant. The controllers designed in this paper are: proportional integral derivative (PID), and sliding table controllers. Simulation results have shown that the sliding table controller can outperform the PID controller even with severe circumstances of disturbance in glucose, such as exercise, delay or noise in glucose sensor and nutrition mixed meal absorption at meal times.

Keywords- diabetes; glucose; PID; sliding table; insulin

I. INTRODUCTION

Many researchers have attempted to find methods for diagnosing and treating diabetes disease. One of the approaches is to design an automated closed-loop insulin delivery system. A fully automated closed-loop insulin delivery system (also known as an artificial pancreas) could potentially be the ultimate answer for blood glucose control in diabetic patients. This system can mimic the activity of a normal pancreas and is capable of maintaining physiological blood glucose levels for insulin-dependent diabetic patients.

Such an artificial pancreas system can theoretically produce tight glucose control without finger-stick blood glucose measurements, subcutaneous insulin injections, or hypo-/hyperglycemic events, thereby dramatically improving the quality of life for an insulin-dependent diabetic patient. The artificial pancreas is a system of integrated devices containing only synthetic materials, which substitutes for a pancreas by sensing plasma glucose concentration, calculating the amount of insulin needed, and then delivering the correct amount of insulin. Typically, such a device is comprised of a glucose monitoring sensor, an insulin pump, and a control algorithm to regulate the pump to deliver the insulin in order to maintain normoglycemia in presence of sensor measurements.

Fig. 1 shows a basic block diagram of this type of closed-loop control for the regulation of glucose levels. In this figure, a controller receives the difference between the glucose set point (desired BG) and the glucose reading, and uses this

information to continuously adjust the rate of insulin delivery. This closed-loop control is very similar to the function that is performed by a healthy human pancreas; in other words, the research's aim is to design a device that essentially functions as an artificial pancreas.

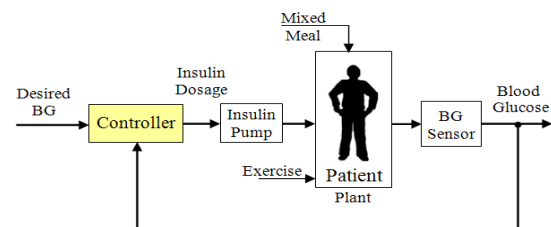

Fig. 1. Block diagram of closed-loop insulin delivery.

II. THE MATHEMATICAL MODEL OF DIABETES

In order to have a reliable model-based automatic insulin delivery system operating under various physiological conditions, a model must be synthesized that has glucose-predicting ability and includes all the major energy-providing substrates at rest, as well as during physical activity. The mathematical models of metabolism proposed to use, in this paper, are glucose-based and have the contribution of free fatty acid (FFA) metabolism, which is an important source of energy for the body. Also, significant interactions exist among FFA, glucose, and insulin.

It is important to consider these metabolic interactions in order to characterize the endogenous energy production of a healthy or diabetic patient. In addition, physiological exercise induces fundamental metabolic changes in the body. A mixed meal model was developed to capture the absorption of carbohydrates (CHO), proteins, and FFA from the gut into the circulatory system. The mixed meal model served as a disturbance to the proposed model. An exercise model was used to incorporate the effects of exercise on glucose and insulin dynamics to capture the changes in glucose and insulin dynamics during and after mild-to-moderate exercise.

A composite model capable of predicting FFA-glucose-insulin dynamics during rest and exercise was developed by Anirban Roy, in his Ph.D. dissertation [1], where the model successfully captured the FFA-glucose interactions at the systemic level, and also successfully predicted mild-to-

moderate exercise effects on glucose and FFA dynamics. Because of this very nature, the composite model was selected in this work to provide a platform for the development of close loop controllers to maintain glucose homeostasis of a diabetic patient. Fig. 2 shows the simulation model of the composite glucose-insulin model used using Simulink in Matlab as a basis for the design of controllers.

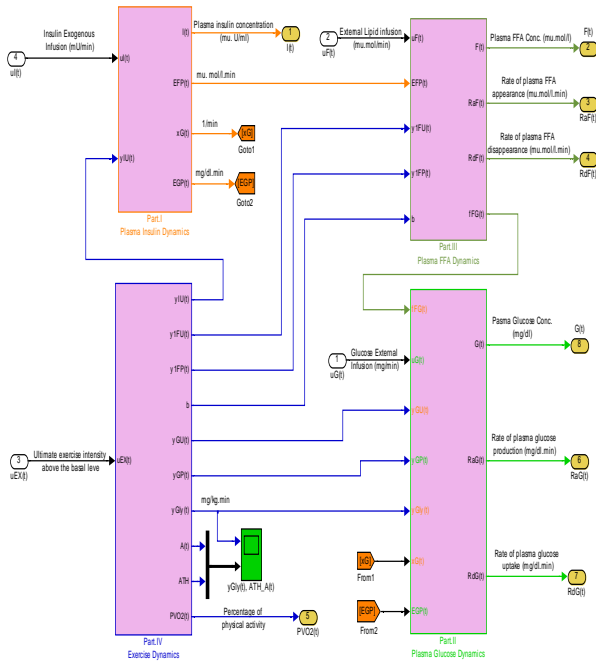

Fig. 2. Simulation of the mathematical model of diabetic patient.

III. CONTROLLERS DESIGN AND SIMULATION

Our studies have focused on using of the mathematical composite model in section two to developing two control algorithms: the PID and Sliding table control using Matlab/Simulink [6]. The target blood glucose range that the controllers were supposed to attain and maintain is similar to healthy blood-glucose levels are between 70 mg/dL and 120 mg/dL before meals and less than 180 mg/dL after meals [2].

A. The PID Controller

The most traditional of all controllers is probably the proportional-integral-derivative (PID) controller. A PID controller uses a proportional term, an integral term, and a derivative term, each with a coefficient that provides a weight for that term. In many processes in industry, PID controllers are used to keep some kind of a steady state [3], [4].

The controller takes a measurement from a plant process and compares it with a set-point (reference) value. The difference (or “error” signal) is then used to adjust the input to the plant in order to bring the measured value back to its desired set-point. PID controller can adjust process outputs based on the history and rate of change of the error signal. The schematic diagram of the PID controller used with the composite model is shown in Fig. 3.

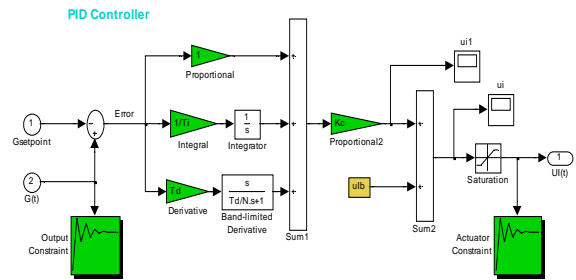

Fig. 3. Simulation of the PID Controller.

B. Sliding Table Controller

This control algorithm translates BG levels readings into matching insulin delivery rates to be given to the patients. The basic sliding table has the form shown in Table I., and features a commonly used starting scale for treating hyperglycaemia in critically ill patients at [5].

TABLE I. BASIC SLIDING TABLE WITH BG RANGES

BG ranges		Insulin infusion rate BG		Region
(mmol/l)	(mg/dl)	(U/hr)	(mU/min)	
> 20.0	> 360	4	66.6	4
15.1 - 20.0	271.8 - 360	3	50	3
10.1 - 15.0	181.8 - 270	2	33.3	2
6.1 - 10.0	109.8 - 180	1	16.66	1
0 - 6.0	0 - 108	0	0	0

Insulin delivery was adjusted at the turn of each sample time, and maintained at the new delivery rate during the sample. The control algorithm was configured to bring BG to the target range, taking a conservative control approach. Fig.4 shows the simulation model used for the sliding table controller.

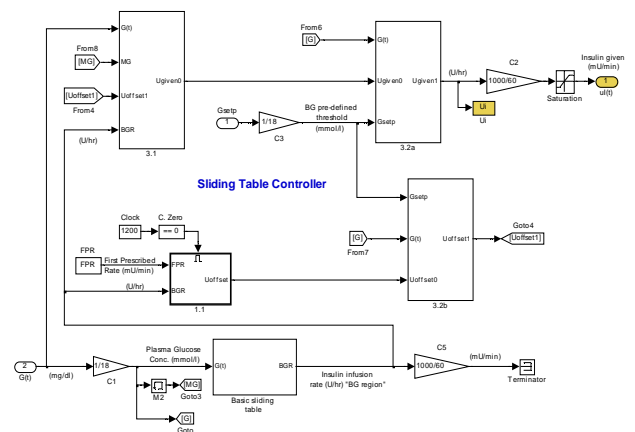

Fig. 4. Simulation of the Sliding Table Controller.

IV. RESULTS OF CONTROLLERS TESTS

This section aims to show side-by-side comparison testing results of the various approaches of closed-loop control of blood glucose levels under a variety of perturbations. Side-by-side comparison testing used to evaluate which controllers yield better blood-glucose regulation, and which controllers minimize the amount of insulin delivered. These types of true comparison were done using common testing procedures.

A. Single Mixed Meal Tests

In this type of test we apply a single mixed meal SMM and all controllers were adjusted to get best response to this test. The following table, Table II. shows the single mixed meal contents used in the simulation.

TABLE II. SINGLE MIXED MEAL AMOUNTS.

Item	Time, min	Glucose, g	FFA, g	Protein, g
Mixed meal	20	70	20	18

Fig.5 shows the response of the plant to the single mixed meal with no controllers. In other words, there is no insulin infusion. Fig.6 shows the response of the plant to the single mixed meal when regulated by the PID method. On the other side, Fig.7 shows the response of the plant when controlled by the sliding table controller. These results were taken under no disturbances.

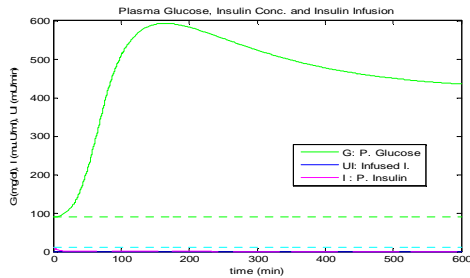

Fig. 5. No control (no infused insulin) response of the plant to the SMM.

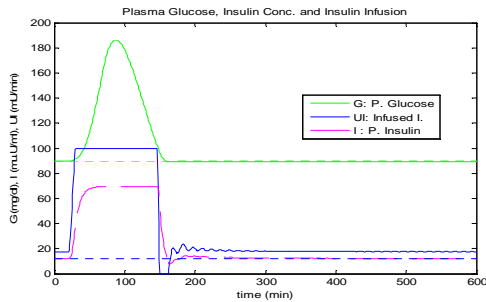

Fig. 6. PID Controller Response to Single Mixed Meal Test.

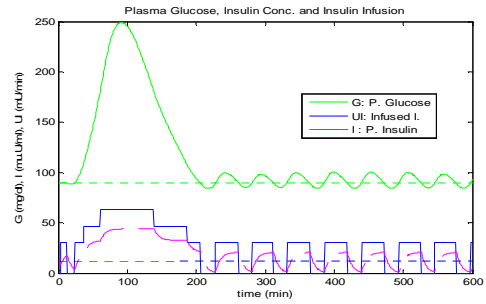

Fig. 7. Sliding Table Controller Response to Single Mixed Meal Test.

B. Daily Life Test

Here, we test how the controllers can deal with multi mixed meals and exercise, by supposing a daily life of a healthy person as shown in Table III.

TABLE III. DAILY LIFE OF MIXED MEALS AND EXERCISE

Item	Time, min	Glucose, g	Protein, g	FFA, g	Percentage of physical activity
Breakfast	20	46	9	10	
Lunch	350	76	18	20	
Exercise	550-640				55 %
Dinner	750	76	18	20	

Although, the mixed meal for lunch and dinner have the same quantity, the blood glucose level has raised after dinner more than after lunch where both controllers has infused more insulin. However, the sliding table controller responded more clearer to blood glucose rise compared to the PID controller, as shown in Fig. 8, and Fig. 9.

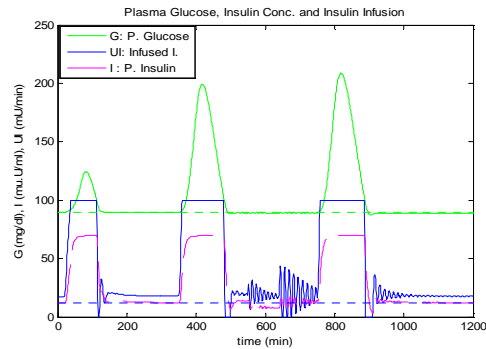

Fig. 8. PID Controller Response to Daily Life Test.

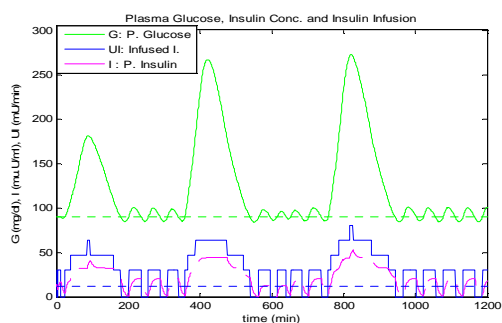

Fig. 9. Sliding Table Controller Response to Daily Life Test.

This result is due to the exercise that was done before the dinner time which caused the plasma FFA elevation. The increased availability of FFA at rest has an inhibitory effect on tissue glucose uptake, as shown in Fig.10.

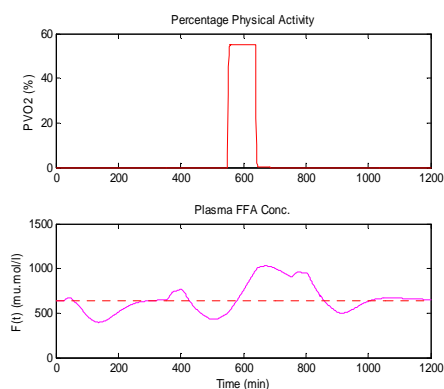

Fig. 10. Top) Percentage Physical Activity, (Bottom) Plasma FFA Concentration.

Table IV. illustrates some measurements of the PID and the sliding table controllers in response to daily life test.

TABLE IV. CONTROLLERS MEASUREMENTS OF DAILY LIFE TEST

Item	PID	Sliding
Maximum glucose (mg/dL)	208.6	272.4
Minimum glucose (mg/dL)	87.45	84.06
Duration of Hyperglycemia (min)	0	10
Duration of Hypoglycemia (min)	0	0
Total infused insulin (U)	49.6	37.84
Infused insulin above basal (U)	30.01	21.93

C. Delay in Glucose Sensor Test

In this test, both controllers were tested against time delay in the glucose sensor (e.g. five minutes delay). The single mixed meal used in the simulation is as shown in the first test Table II. The response of the plant to the single mixed meal with time delay when controlled by the PID algorithm is shown in Fig. 11. For a matter of comparison, the response of the plant when controlled by the sliding table controller is shown in Fig. 12.

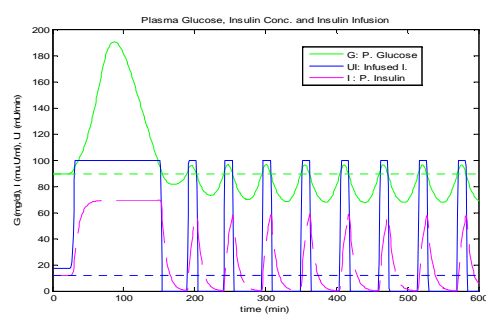

Fig. 11. PID Controller Response to 5 min Time Delay Test.

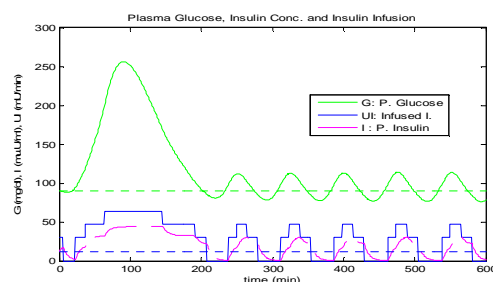

Fig. 12. Sliding Table Controller Response to 5 min Time Delay Test.

D. Noise in Glucose Sensor Test

In this type of test we apply a single mixed meal as shown in the last section, with signal to noise ratio (SNR = 10 dB) in the glucose sensor. The simulation results for both controllers are shown in Fig. 13, and Fig. 14. Table V. illustrates the results of controllers response to different tests on single mixed meal.

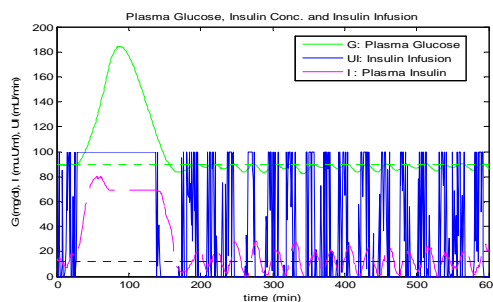

Fig. 13. PID Controller Response to Noise in Glucose Sensor Test.

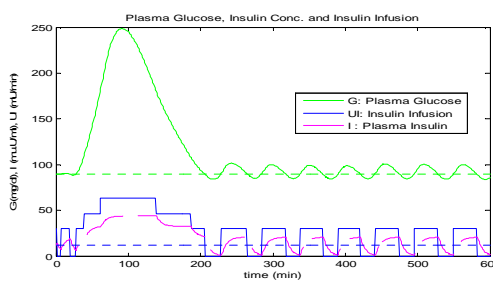

Fig. 14. Sliding Table Controller Response to Noise in Glucose Sensor Test.

TABLE V. RESULTS OF CONTROLLERS RESPONSE TO DIFFERENT TESTS ON SINGLE MIXED MEAL

Item	No Disturbance		Sensor Delay		Sensor Noise		No Control
	PID	Sliding	PID	Sliding	PID	Sliding	
Maximum glucose (mg/dL)	186.5	249.1	196	248.7	184.6	248.7	591.5
Minimum glucose (mg/dL)	88.97	84.15	67.77	76.2	82.26	83.79	89.58
Duration of Hyperglycemia (min)	0	0	0	0	0	0	541
Duration of Hypoglycemia (min)	0	0	0	0	0	0	0
Total infused insulin (U)	20.49	16.43	22.92	17.41	27.09	16.47	0
Infused insulin above basal (U)	10.26	9.064	18.61	10.18	21.58	9.051	0

V. CONCLUSIONS

The PID controller in daily life test has an ideal response where soon after the overshoot that happened due to the ingestion of mixed meal, the blood glucose BG level returned back to the basal level. In contrast, the overshoot in the Sliding controller is more than that what happened in the PID controller, where the effect of long time of high overshoot has a long term effect on the life of the patient. In the stage of steady state the sliding controller has an oscillation in blood glucose level. In the second test when the glucose sensor has 5 minutes time delay, the PID controller cannot keep the blood glucose level at the basal level. This drop in blood glucose level is below the basal line is due to the wrong insulin doses causing danger to the patient, which has a short term effect on his/her life. In contrast, the overshoot in the Sliding controller is more than what happened in the PID controller, however, the sliding table controller has a less drop with almost constant oscillation around the steady state in blood glucose level. Thus, less infused insulin is required.

In the third test when the glucose sensor has a 10 dB SNR, this caused a big confusion in the response of the PID controller and this is shown clearly in the stage of steady state before and after the time of ingesting the mixed meal. The response of the PID controller is not acceptable in the sense of control since the blood glucose level has an oscillation causing a big drop in blood glucose level below the basal. In contrast,

although the overshoot in the Sliding controller is more than that what happen in the PID controller, the controller has a stable oscillation in blood glucose level and less drop. Thereby, requiring less insulin infusion. In conclusion, taking into account all the previous testing circumstances, resulting tables and figures have shown that sliding table controller is more reliable, safer and less insulin consumption than the PID controller. Moreover, real world cases should have a delay or/and noise in glucose sensor. Therefore, sliding table control would be preferable and advisable when it comes to critical diabetes cases.

REFERENCES

- [1] Roy, A., "Dynamic modeling of free fatty acid, glucose, and insulin during rest and exercise in insulin dependent diabetes mellitus patients," Ph.D dissertation, University of Pittsburgh, 2008.
- [2] Emily S. Berger, "Modelling diabetes to achieve closed-loop control of glucose levels: a literature review", Penn State Great Valley, School of Graduate Professional Studies, 2007.
- [3] Chen J., Cao K., Sun Y., Xiao Y., and Su X., "Continuous drug infusion for diabetes therapy: a closed-loop control system design," Eurasip Journal on Wireless Communications and Networking, vol. 2008, No. 44, 2008, Article ID: 495185.
- [4] Lehman E. D., Deutsch T., "The physiological model of glucose-insulin interaction in T1DM," Journal Biomedical Engineering, vol. 14, No. 3, 1992, pp. 235-242. doi:10.1016/0141-5425(92)90058-S
- [5] Frederick, Chee, and Fernando Tyrone, Closed-loop Control of Blood Glucose, Springer-Verlag Berlin Heidelberg, Lecture Notes in Control and Information Sciences, vol. 368, 2007.
- [6] E. Friis, "Modeling and simulation of glucose-insulin metabolism," B.Sc thesis, Technical University of Denmark, 2007.